







BARDIYA NARROW

Linear Family IP20 IK05   $T_a 25$    

THE FAMILY OF RECESSED MOUNT TRIMLESS LINEAR OPERATING AT 20 W/M, 220-240 VAC INPUT. DELIVERING OUT STANDING PERFORMANCE OF 2000LM/M.

Technical description

Recesses mount and trimless of linear system for indoor general lighting. The lumenline is a linear system of LED luminaires which can be integrated in most ceiling types to provide a discreet flexible general lighting solution for commercial and institutional environments such as offices and class rooms. Color temperature is 3000 – 6000 kelvin . A LED Luminaires, flat direct LED with the top of the optical polystyrene diffuser screen and extruded powder coating hard anodizing aluminum body, with aluminum end caps complete with silicone seals. Symmetric optic. Class I electrical and IP20 (IP54 just for option) with plug and play connector. Total power: 20 w/m, slave luminaire for DALI control (an option only) with LED converter.

Chromaticity tolerance (initial Macadam: 3).

Color rendering $R_a > 80$.

This product can be produced in any sizes.



Application

- Corridors
- Office
- General
- Parking

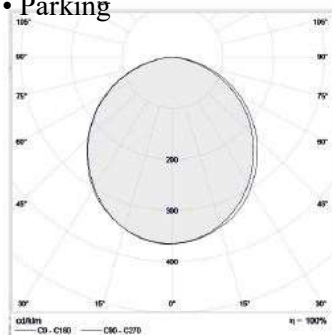

Correlated color temperature: 3000 – 6000 kelvin
Rated median useful life: 50000h L70 at 25°C Luminaire
input power: 20 w/m

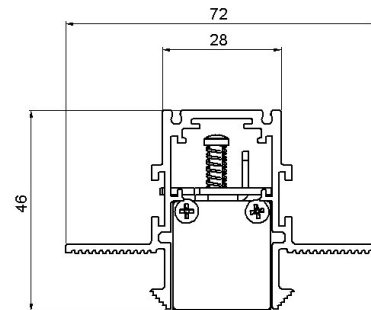

Dimensions: 1000 x 72 x 46mm
Total power: 20w
Luminaire luminous flux: 2000 lm
Luminaire efficacy: 100 lm/w
Weight: 1 kg

Mounting and installation

Recessed mount using the accessories to be ordered separately. **Cut-out diameters: 37 mm.**